



**MODULE INSTALLATION  
AND USER MANUAL - PERC  
AND MONO SERIES**

REV13 | 4/28/2020

## TABLE OF CONTENTS

<b>1.0</b>	<b>DISCLAIMER .....</b>	<b>3</b>
<b>2.0</b>	<b>HANDLING AND USE .....</b>	<b>3</b>
<b>3.0</b>	<b>LIMITATION OF LIABILITY AND LIMITED REMEDIES .....</b>	<b>3</b>
<b>4.0</b>	<b>GENERAL INSTRUCTIONS .....</b>	<b>3</b>
<b>5.0</b>	<b>SAFETY .....</b>	<b>4</b>
5.1	General Warning .....	4
5.2	Mechanical .....	4
5.3	Electrical Shock Hazard .....	4
5.4	Fire.....	4
<b>6.0</b>	<b>OPERATING CONDITIONS .....</b>	<b>5</b>
6.1	Temperature .....	5
6.2	Installation Condition .....	5
<b>7.0</b>	<b>UNPACKING &amp; STORAGE .....</b>	<b>6</b>
7.1	General Instructions.....	6
7.2	Unpacking Instructions.....	7
<b>8.0</b>	<b>PRODUCT SPECIFICATION .....</b>	<b>9</b>
	Table 1: Electrical Ratings of MSE PERC 72 (5BB) Module Series .....	9
1)	SQ9S/SQ7S Series .....	9
2)	SR9S/SR7S SERIES.....	9
	Table 2: Electrical Ratings of MSE MONO 72 (5BB) Module Series.....	9
	Table 3: Electrical Ratings of MSE PERC 60 (5BB, BLACK) Module Series .....	10
1)	SQ8T Series.....	10
2)	SR8T Series .....	10
	Table 4: Electrical Ratings of MSE PERC 60 (5BB, WHITE) Module Series.....	10
1)	SQ8K Series.....	10
2)	SR8K Series.....	10
<b>9.0</b>	<b>MECHANICAL INSTALLATION.....</b>	<b>11</b>
	<b>TABLE 5: SNOW &amp; WIND LOAD AS SPECIFIED BY UL1703 .....</b>	<b>12</b>

### MISSION SOLAR ENERGY LLC

ELECTRONIC versions are uncontrolled except when accessed directly from document control directory. Printed copies are uncontrolled unless verified against online document.

COPYRIGHT 2019 MISSION SOLAR ENERGY LLC, ALL RIGHTS RESERVED

REVISION:[R13] 4/28/2020

RELEASE DATE: 11/16/2016

**10.0 GROUNDING INSTRUCTIONS ..... 15**

10.1 WEEB-UIR ..... 15

**11.0 ELECTRICAL INSTALLATION ..... 16**

11.1 Local / National Code and Local Regulation..... 16

11.2 Wiring ..... 16

11.3 Connectors ..... 17

11.4 Diodes..... 17

**12.0 MAINTENANCE ..... 18**

12.1 Visual Inspection ..... 18

12.2 Cleaning..... 18

## 1.0 DISCLAIMER

This manual is provided on an “as is” basis without warranty, covenant or representative of any kind, express or implied, including the warranties of merchantability or fitness for a particular purpose. Mission Solar Energy uses its best efforts to ensure the accuracy of the contents of this manual; however, Mission Solar Energy is not responsible for the accuracy of said contents or results of your use of the same. Under no circumstances will Mission Solar Energy be liable to you or any third party for damages arising under any legal theory including contract, tort, negligence or strict liability or for direct, indirect, special, consequential; or punitive damages of any kind, including lost profits. Mission Solar Energy reserves the right to make changes without further notice to this manual and to any modules. Mission Solar Energy does not convey any license under its intellectual property rights. Mission Solar Energy assumes no responsibility for any infringement to patents or other rights of third parties that may result from use of this manual or related module.

## 2.0 HANDLING AND USE

Mission Solar Energy shall not be liable for, and buyer shall indemnify, defend and hold harmless Mission Solar Energy, its affiliates and their respective officers, directors, employees, representatives and agents (“indemnities”) from and against, any and all claims, losses, liabilities, costs and expenses (including attorneys’ fees) (“claims”) arising out of or resulting from the handling, use, processing, alteration, distributions, sale or marketing of modules and this manual, or any other action or inaction with regard to the modules and this manual, in each case after the delivery thereof to buyer; provided however, that buyer shall not be liable to Mission Solar Energy for damages directly caused by the sole negligence of Mission Solar Energy. Buyer’s obligations under this section shall survive the termination, cancellations or expiration of all orders delivered under these terms and the cessation of any business transaction between Mission Solar Energy and buyer.

## 3.0 LIMITATION OF LIABILITY AND LIMITED REMEDIES

In no event will Mission Solar Energy be liable to buyer for any lost or prospective profits, indirect, incidental, consequential, special, exemplary or punitive damages, including, without limitation, lost earnings, or business interruption, whether or not based upon Mission Solar Energy’s negligence, breach of warranty, strict liability, in tort or any other cause of action. Buyer’s exclusive remedy VIS-À-VIS Mission Solar Energy or any other cause if action related to the modules and this manual is at Mission Solar Energy’s option limited to (i) replacement of the non-conforming modules; or (ii) refund to buyer of the portion of the purchase of the purchase price attributable to such non-conforming modules. In no event shall Mission Solar Energy’s cumulative liability exceed the price of modules sold which was the direct cause of the alleged loss, damage or injury.

## 4.0 GENERAL INSTRUCTIONS

This manual provides important safety instructions regarding installation, maintenance and handling of Mission Solar Energy photovoltaic modules. All the users should read this manual carefully and follow the instructions strictly. The installation of solar modules requires specialized skills and experience and should only be performed by licensed professionals.

## 5.0 SAFETY

### WARNING



### 5.1 GENERAL WARNING

You must understand and follow all applicable local, state and federal regulations in addition to standards for building construction, electrical design, fire and safety. Check with local authorities to determine applicable permitting requirements before attempting to install or maintain PV modules.

- Module interconnects pass direct current (DC) when exposed to sunlight or other light sources.
- Contact with electrically active parts of the module, such as terminals, can result in injury or death, whether the module is connected or disconnected.
- Never wear metallic rings, watch bands, ear, nose or lip rings or other metallic devices when installing or trouble shooting a photovoltaic system.

### 5.2 MECHANICAL

- Rooftop PV systems should only be installed on dwellings that have been formally analyzed for structural integrity, and confirmed to be capable of handling the additional weighted load of PV system components including PV modules by a certified building specialist or engineer. For your safety, do not attempt to work on a rooftop until safety precautions have been identified and taken, including without limitation fall protection measures, ladders or stairways, and personal protective equipment (PPE).
- For your safety, do not install or handle PV modules under adverse conditions, including and without limitation - strong or gusty winds and wet or frosted roof surfaces.
- The flat-plate PV module construction consists of a laminated assembly of solar cells encapsulated within an insulating material with a rigid glass surface and an insulated substrate. The laminated assembly is supported by an aluminum frame that is also used for mounting the module.

### 5.3 ELECTRICAL SHOCK HAZARD

- PV modules can produce current and voltage when exposed to light of any intensity. Electrical current increases with higher light intensity.
- DC voltage of 30 Volts or higher is potentially lethal. Contacting the live circuitry of a PV system operating under light can result in lethal electric shock.
- Use insulated tools and do not wear metallic jewelry while working with PV modules.  
In order to avoid arcing and electrical shock, do not disconnect electrical connections under load.
- Faulty connections can also result in arcing and electrical shock.

- Keep connectors dry and clean; ensure that they are in proper working condition.
- Never insert metallic objects into the connectors, or modify them in any way in order to secure an electrical connection.
- Do not touch or handle PV modules with broken glass, separated frames or a damaged back sheet unless the PV modules are first disconnected and you are wearing proper PPE.
- Avoid handling PV modules when they are wet unless cleaning the PV modules as directed in this manual. **See 12.2 Cleaning.**
- Never touch electrical connections that are wet without protecting yourself with insulated gloves. Artificially concentrated light should not be directed on the module or panel.



### 5.4 FIRE

- Mission Solar Energy modules have a Type 1, Class C fire resistance rating in accordance with the IEC 61730 and UL 1703 standard.
- The fire rating of this module is valid only when mounted in the manner specified in the mechanical mounting instructions. See 9.0 Mechanical Installation
- PV modules are electricity generating devices that may affect the fire safety of a building.
- The use of improper installation methods and/or defective parts may result in the unexpected occurrence of an electrical arc during operation.
- The recommended standoff height is no less than 150mm (6 inches). If other mounting means are employed this may affect the fire class ratings. A minimum slope of 5in/ft. for installation over a roof is required to maintain the class C fire rating. Modules must be mounted over a fire resistant roof covering rated for the application.
- In order to mitigate the risk of fire in this event, PV modules should not be installed near flammable liquids, gases and/or locations with hazardous materials.
- In the event of a fire, PV modules may continue to produce a dangerous voltage, even if they have been disconnected from the inverter, have been partly or entirely destroyed, or the system wiring has been compromised or destroyed.
- In the event of fire, inform the fire crew about the particular hazards from the PV system, and stay away from all elements of the PV system during and after a fire until the necessary steps have been taken to make the PV system safe.

## 6.0 OPERATING CONDITIONS

### 6.1 TEMPERATURE

All the modules must be mounted in environments that ensure they operate within the following maximum and minimum operating temperatures.

- Maximum Operating Temperatures: +90°C (194°F)
- Minimum Operating Temperatures: -40°C (-40°F)

### 6.2 INSTALLATION CONDITION

Orient the module correctly. Mount the modules with the junction box in the uppermost position and hang the wires downwards to avoid the ingress of water. For optimal module performance install PV modules facing true south in northern latitudes and true north in southern latitudes. Shading will reduce electrical production. This installation is applicable when the module is in portrait orientation. The modules have been evaluated by UL standards for mounting using the recommended mounting positions.



Photo Credit: Go Smart Solar

#### MISSION SOLAR ENERGY LLC

ELECTRONIC versions are uncontrolled except when accessed directly from document control directory. Printed copies are uncontrolled unless verified against online document.

**COPYRIGHT 2019 MISSION SOLAR ENERGY LLC, ALL RIGHTS RESERVED**

REVISION:[R13] 4/28/2020

RELEASE DATE: 11/16/2016

Always wear Proper PPE when handling MSE Panels

## 7.0 UNPACKING & STORAGE

### 7.1 GENERAL INSTRUCTIONS



Store modules in an environment consistent with prudent solar industry practices, including, storage in dry conditions such that modules (or any part thereof) are not immersed in water.



Do not carry the module above the head.



Do not allow children or unauthorized persons near the installation site or storage area of modules.



Do not drop or place objects such as tools on the modules.



Do not use forklifts with less than 72 inch forks to handle module pallet.



Do not mark the modules with sharp instruments.



Unpack the module pallet with care and follow the unpacking steps in this manual. Be careful when unpacking, transporting and storing the modules.



Particular attention should be taken to avoid module back sheet contact with sharp objects. Scratches may directly affect product safety.



Do not carry a module by its wires or junction box. At least two or more people are recommended to carry the module for safe handling.



Do not leave a module unsupported or unsecured.



Do not place modules directly on top of each other and prevent modules from touching one another.



Do not change the wiring of bypass diodes.



Do not place excessive loads on the module or twist the module frame.



Keep all electrical contacts clean and dry.



Do not stand, step, walk and/or jump on the module.



Modules may have sharp frame corners, use of puncture and cut-resistant gloves is recommended.

#### MISSION SOLAR ENERGY LLC

ELECTRONIC versions are uncontrolled except when accessed directly from document control directory. Printed copies are uncontrolled unless verified against online document.

COPYRIGHT 2019 MISSION SOLAR ENERGY LLC, ALL RIGHTS RESERVED

REVISION:[R13] 4/28/2020

RELEASE DATE: 11/16/2016

## 7.2 UNPACKING INSTRUCTIONS

Always wear Proper PPE when handling MSE Panels



Prior to unpacking, ensure pallet is set on a level surface and proper PPE is equipped by all personnel. Proper PPE for unpacking includes but is not limited to eye protection, cut-resistant gloves and steel-toe footwear.



Cut the two green strips of banding material with scissors. These strips are under high tension and will snap when cut. Eye protection is highly recommended.



Lift the pallet lid and set away from unpacking area.



Using a box cutter, carefully cut along the corner from the top to the middle of the box on the packing slip side. Ensure the blade stays on the outside and does not cut through the white corner protectors.

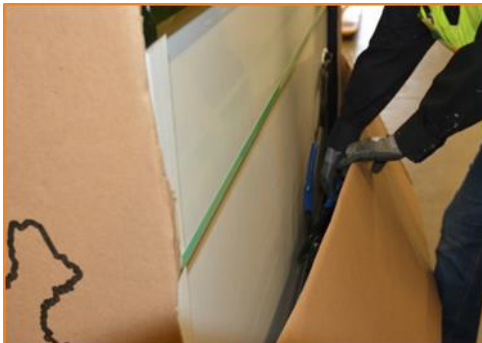

After both corners have been cut, fold the lengthwise side of the box halfway down allowing easy access to the modules. Cut the internal banding material as well being careful to avoid contact with the modules.



Peel back sides of box to allow additional access to modules.



(Optional) Apply no-residue tape across the plastic corner clips to provide additional support to stack as modules are removed.



(Optional) Tape must reach at least 6 inches down on opposite side of box to maintain hold.



Remove white corner protectors.

### MISSION SOLAR ENERGY LLC

ELECTRONIC versions are uncontrolled except when accessed directly from document control directory. Printed copies are uncontrolled unless verified against online document.

COPYRIGHT 2019 MISSION SOLAR ENERGY LLC, ALL RIGHTS RESERVED

REVISION:[R13] 4/28/2020

RELEASE DATE: 11/16/2016



Always wear Proper PPE when handling MSE Panels



(Optional) If tape has been used to provide additional support to module stack, peel tape back as needed to remove individual modules.



The first module must be separated and pulled out with additional care so as to not scratch the modules. Continue removing modules by peeling back tape, moving the module forward and pulling it up.



When four modules remain, the stack will inherently become prone to tipping over. At this point, ensure two personnel are available to secure the stack.



Slide the remaining modules to the front of the box.



Carefully lower modules down to a horizontal position with the glass side down.



Remove box sleeve allowing easy access to remaining modules from the horizontal stack.

#### MISSION SOLAR ENERGY LLC

ELECTRONIC versions are uncontrolled except when accessed directly from document control directory. Printed copies are uncontrolled unless verified against online document.

**COPYRIGHT 2019 MISSION SOLAR ENERGY LLC, ALL RIGHTS RESERVED**

REVISION:[R13] 4/28/2020

RELEASE DATE: 11/16/2016

## 8.0 PRODUCT SPECIFICATION

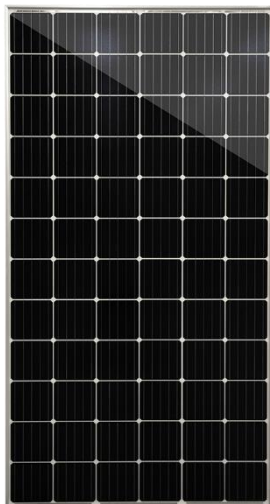

PV Modules have been certified to IEC 61215 for a maximum static load on the back of the module of up to 2400 Pa (i.e. wind load) and a maximum static load on the front of the module of up to either 2400 Pa or 5400 Pa (i.e. wind and snow load). For UL 1703 only, PV modules are tested to a front side and rear side applied load based on 78 psf design load. The performance of solar modules is defined on the uniform standard test conditions. These conditions define performance at an incident sunlight of 1000 W/m<sup>2</sup>, a cell temperature of 25°C (77°F) and an AM of 1.5 (AM = Air Mass). The air mass determines the radiation impact and the spectral combination of the light arriving on the earth's surface.

**TABLE 1: ELECTRICAL RATINGS OF MSE PERC 72 (5BB) MODULE SERIES**

### 1) SQ9S/SQ7S SERIES

Model – P PERC Crystalline	Open Circuit Voltage at STC, (V dc)	Rated Voltage at STC, (V dc)	Maximum System Voltage, (V dc)	Rated Current at STC, (A dc)	Short-Circuit Current at STC, (A dc)	Rated Maximum Power at STC, (Watts)
MSE355SQ9S /MSE355SQ7S	47.44 ± (0% - 3%)	39.20 ± (0% - 3%)	1500/1000	9.058 ± (0% - 3%)	9.620 ± (0% - 3%)	355.00 ± (0% - 3%)
MSE360SQ9S / MSE360SQ7S	47.83 ± (0% - 3%)	39.38 ± (0% - 3%)	1500/1000	9.143 ± (0% - 3%)	9.661 ± (0% - 3%)	360.00 ± (0% - 3%)
MSE365SQ9S / MSE365SQ7S	48.05 ± (0% - 3%)	39.52 ± (0% - 3%)	1500/1000	9.236 ± (0% - 3%)	9.705 ± (0% - 3%)	365.00 ± (0% - 3%)
MSE370SQ9S /MSE370SQ7S	48.08 ± (0% - 3%)	39.69 ± (0% - 3%)	1500/1000	9.323 ± (0% - 3%)	9.767 ± (0% - 3%)	370.00 ± (0% - 3%)
MSE375SQ9S /MSE375SQ7S	48.16 ± (0% - 3%)	39.76 ± (0% - 3%)	1500/1000	9.432 ± (0% - 3%)	9.826 ± (0% - 3%)	375.00 ± (0% - 3%)
MSE380SQ9S /MSE380SQ7S	48.17 ± (0% - 3%)	39.78 ± (0% - 3%)	1500/1000	9.552 ± (0% - 3%)	9.904 ± (0% - 3%)	380.00 ± (0% - 3%)
MSE385SQ9S /MSE385SQ7S	48.24 ± (0% - 3%)	40.08 ± (0% - 3%)	1500/1000	9.605 ± (0% - 3%)	9.947 ± (0% - 3%)	385.00 ± (0% - 3%)

### 2) SR9S/SR7S SERIES

Model – P PERC Crystalline	Open Circuit Voltage at STC, (V dc)	Rated Voltage at STC, (V dc)	Maximum System Voltage, (V dc)	Rated Current at STC, (A dc)	Short-Circuit Current at STC, (A dc)	Rated Maximum Power at STC, (Watts)
MSE375SR9S /MSE375SR7S	48.02 ± (0% - 3%)	40.06 ± (0% - 3%)	1500/1000	9.360 ± (0% - 3%)	9.939 ± (0% - 3%)	375.00 ± (0% - 3%)
MSE380SR9S / MSE380SR7S	48.31 ± (0% - 3%)	40.49 ± (0% - 3%)	1500/1000	9.385 ± (0% - 3%)	9.966 ± (0% - 3%)	380.00 ± (0% - 3%)
MSE385SR9S / MSE385SR7S	48.53 ± (0% - 3%)	40.84 ± (0% - 3%)	1500/1000	9.426 ± (0% - 3%)	9.993 ± (0% - 3%)	385.00 ± (0% - 3%)
MSE390SR9S / MSE390SR7S	48.96 ± (0% - 3%)	41.05 ± (0% - 3%)	1500/1000	9.499 ± (0% - 3%)	10.024 ± (0% - 3%)	390.00 ± (0% - 3%)
MSE395SR9S / MSE395SR7S	49.28 ± (0% - 3%)	41.44 ± (0% - 3%)	1500/1000	9.532 ± (0% - 3%)	10.045 ± (0% - 3%)	395.00 ± (0% - 3%)
MSE400SR9S / MSE400SR7S	49.46 ± (0% - 3%)	41.62 ± (0% - 3%)	1500/1000	9.610 ± (0% - 3%)	10.067 ± (0% - 3%)	400.00 ± (0% - 3%)

**TABLE 2: ELECTRICAL RATINGS OF MSE MONO 72 (5BB) MODULE SERIES**

Model – P PERC Crystalline	Open Circuit Voltage at STC, (V dc)	Rated Voltage at STC, (V dc)	Maximum System Voltage, (V dc)	Rated Current at STC, (A dc)	Short-Circuit Current at STC, (A dc)	Rated Maximum Power at STC, (Watts)
MSE330SO9J / MSE330SO7J	45.85 ± (0% - 3%)	37.43 ± (0% - 3%)	1500 / 1000	8.816 ± (0% - 3%)	9.325 ± (0% - 3%)	330.00 ± (0% - 3%)
MSE335SO9J / MSE335SO7J	46.05 ± (0% - 3%)	37.62 ± (0% - 3%)	1500 / 1000	8.904 ± (0% - 3%)	9.410 ± (0% - 3%)	335.00 ± (0% - 3%)
MSE340SO9J /MSE340SO7J	46.21 ± (0% - 3%)	37.77 ± (0% - 3%)	1500/1000	9.002 ± (0% - 3%)	9.505 ± (0% - 3%)	340.00 ± (0% - 3%)
MSE345SO9J /MSE345SO7J	46.47 ± (0% - 3%)	37.99 ± (0% - 3%)	1500/1000	9.082 ± (0% - 3%)	9.583 ± (0% - 3%)	345.00 ± (0% - 3%)
MSE350SO9J /MSE350SO7J	46.69 ± (0% - 3%)	38.14 ± (0% - 3%)	1500/1000	9.183 ± (0% - 3%)	9.681 ± (0% - 3%)	350.00 ± (0% - 3%)

#### MISSION SOLAR ENERGY LLC

ELECTRONIC versions are uncontrolled except when accessed directly from document control directory. Printed copies are uncontrolled unless verified against online document.

COPYRIGHT 2019 MISSION SOLAR ENERGY LLC, ALL RIGHTS RESERVED

REVISION:[R13] 4/28/2020

RELEASE DATE: 11/16/2016

TABLE 3: ELECTRICAL RATINGS OF MSE PERC 60 (5BB, BLACK) MODULE SERIES

## 1) SQ8T SERIES

Model – P PERC Crystalline	Open Circuit Voltage at STC, (V dc)	Rated Voltage at STC, (V dc)	Maximum System Voltage, (V dc)	Rated Current at STC, (A dc)	Short-Circuit Current at STC, (A dc)	Rated Maximum Power at STC, (Watts)
MSE285SQ8T	39.69 ± (0% - 3%)	32.68 ± (0% - 3%)	1000	8.720 ± (0% - 3%)	9.367 ± (0% - 3%)	285.00 ± (0% - 3%)
MSE290SQ8T	39.91 ± (0% - 3%)	32.91 ± (0% - 3%)	1000	8.811 ± (0% - 3%)	9.420 ± (0% - 3%)	290.00 ± (0% - 3%)
MSE295SQ8T	40.07 ± (0% - 3%)	33.10 ± (0% - 3%)	1000	8.912 ± (0% - 3%)	9.480 ± (0% - 3%)	295.00 ± (0% - 3%)
MSE300SQ8T	40.08 ± (0% - 3%)	33.12 ± (0% - 3%)	1000	9.058 ± (0% - 3%)	9.571 ± (0% - 3%)	300.00 ± (0% - 3%)
MSE305SQ8T	40.10 ± (0% - 3%)	33.14 ± (0% - 3%)	1000	9.202 ± (0% - 3%)	9.664 ± (0% - 3%)	305.00 ± (0% - 3%)
MSE310SQ8T	40.12 ± (0% - 3%)	33.17 ± (0% - 3%)	1000	9.345 ± (0% - 3%)	9.760 ± (0% - 3%)	310.00 ± (0% - 3%)
MSE315SQ8T	40.13 ± (0% - 3%)	33.20 ± (0% - 3%)	1000	9.489 ± (0% - 3%)	9.901 ± (0% - 3%)	315.00 ± (0% - 3%)
MSE320SQ8T	40.14 ± (0% - 3%)	33.32 ± (0% - 3%)	1000	9.605 ± (0% - 3%)	9.996 ± (0% - 3%)	320.00 ± (0% - 3%)

## 2) SR8T SERIES

Model – P PERC Crystalline	Open Circuit Voltage at STC, (V dc)	Rated Voltage at STC, (V dc)	Maximum System Voltage, (V dc)	Rated Current at STC, (A dc)	Short-Circuit Current at STC, (A dc)	Rated Maximum Power at STC, (Watts)
MSE310SR8T	40.14 ± (0% - 3%)	33.69 ± (0% - 3%)	1000	9.202 ± (0% - 3%)	9.967 ± (0% - 3%)	310.00 ± (0% - 3%)
MSE315SR8T	40.44 ± (0% - 3%)	34.04 ± (0% - 3%)	1000	9.253 ± (0% - 3%)	9.997 ± (0% - 3%)	315.00 ± (0% - 3%)
MSE320SR8T	40.80 ± (0% - 3%)	34.22 ± (0% - 3%)	1000	9.351 ± (0% - 3%)	10.028 ± (0% - 3%)	320.00 ± (0% - 3%)
MSE325SR8T	41.14 ± (0% - 3%)	34.62 ± (0% - 3%)	1000	9.387 ± (0% - 3%)	10.060 ± (0% - 3%)	325.00 ± (0% - 3%)
MSE330SR8T	41.36 ± (0% - 3%)	34.84 ± (0% - 3%)	1000	9.472 ± (0% - 3%)	10.094 ± (0% - 3%)	330.00 ± (0% - 3%)

TABLE 4: ELECTRICAL RATINGS OF MSE PERC 60 (5BB, WHITE) MODULE SERIES

## 1) SQ8K SERIES

Model – P PERC Crystalline	Open Circuit Voltage at STC, (V dc)	Rated Voltage at STC, (V dc)	Maximum System Voltage, (V dc)	Rated Current at STC, (A dc)	Short-Circuit Current at STC, (A dc)	Rated Maximum Power at STC, (Watts)
MSE290SQ8K	39.00 ± (0% - 3%)	32.30 ± (0% - 3%)	1000	8.982 ± (0% - 3%)	9.561 ± (0% - 3%)	290.00 ± (0% - 3%)
MSE295SQ8K	39.24 ± (0% - 3%)	32.68 ± (0% - 3%)	1000	9.027 ± (0% - 3%)	9.578 ± (0% - 3%)	295.00 ± (0% - 3%)
MSE300SQ8K	39.66 ± (0% - 3%)	32.95 ± (0% - 3%)	1000	9.104 ± (0% - 3%)	9.652 ± (0% - 3%)	300.00 ± (0% - 3%)
MSE305SQ8K	39.96 ± (0% - 3%)	33.02 ± (0% - 3%)	1000	9.238 ± (0% - 3%)	9.723 ± (0% - 3%)	305.00 ± (0% - 3%)
MSE310SQ8K	40.09 ± (0% - 3%)	33.11 ± (0% - 3%)	1000	9.362 ± (0% - 3%)	9.819 ± (0% - 3%)	310.00 ± (0% - 3%)
MSE315SQ8K	40.13 ± (0% - 3%)	33.28 ± (0% - 3%)	1000	9.465 ± (0% - 3%)	9.917 ± (0% - 3%)	315.00 ± (0% - 3%)
MSE320SQ8K	40.22 ± (0% - 3%)	33.35 ± (0% - 3%)	1000	9.595 ± (0% - 3%)	10.007 ± (0% - 3%)	320.00 ± (0% - 3%)
MSE325SQ8K	40.25 ± (0% - 3%)	33.39 ± (0% - 3%)	1000	9.732 ± (0% - 3%)	10.106 ± (0% - 3%)	325.00 ± (0% - 3%)

## 2) SR8K SERIES

Model – P PERC Crystalline	Open Circuit Voltage at STC, (V dc)	Rated Voltage at STC, (V dc)	Maximum System Voltage, (V dc)	Rated Current at STC, (A dc)	Short-Circuit Current at STC, (A dc)	Rated Maximum Power at STC, (Watts)
MSE315SR8K	40.14 ± (0% - 3%)	33.68 ± (0% - 3%)	1000	9.352 ± (0% - 3%)	9.963 ± (0% - 3%)	315.00 ± (0% - 3%)
MSE320SR8K	40.38 ± (0% - 3%)	33.92 ± (0% - 3%)	1000	9.435 ± (0% - 3%)	9.988 ± (0% - 3%)	320.00 ± (0% - 3%)
MSE325SR8K	40.80 ± (0% - 3%)	34.21 ± (0% - 3%)	1000	9.499 ± (0% - 3%)	10.024 ± (0% - 3%)	325.00 ± (0% - 3%)
MSE330SR8K	41.06 ± (0% - 3%)	34.53 ± (0% - 3%)	1000	9.556 ± (0% - 3%)	10.045 ± (0% - 3%)	330.00 ± (0% - 3%)
MSE335SR8K	41.36 ± (0% - 3%)	34.83 ± (0% - 3%)	1000	9.618 ± (0% - 3%)	10.090 ± (0% - 3%)	335.00 ± (0% - 3%)

## MISSION SOLAR ENERGY LLC

ELECTRONIC versions are uncontrolled except when accessed directly from document control directory. Printed copies are uncontrolled unless verified against online document.

COPYRIGHT 2019 MISSION SOLAR ENERGY LLC, ALL RIGHTS RESERVED

REVISION:[R13] 4/28/2020

RELEASE DATE: 11/16/2016

## 9.0 MECHANICAL INSTALLATION

The module is considered to be in compliance with UL 1703 only when the module is mounted in the manner specified by the mounting options below. Per UL standards, the maximum number of modules connected in series/parallel for 60-cell module is 19/1, for 72-cell module with maximum system voltage of 1000V is 16/1 and 72-cell module with maximum system voltage of 1500V is 24/1. However, please refer to your local Authority Having Jurisdiction (AHJ) as well as best installation practices for the maximum number of modules that can be installed in series and in parallel for your specific installation project site and application.



### 9.1 MOUNTING OPTIONS

Make sure that the module is evenly between the two rails and sits perpendicular on the railing. If the module is not perpendicular, slightly adjust the clamp positions to get the proper alignment.

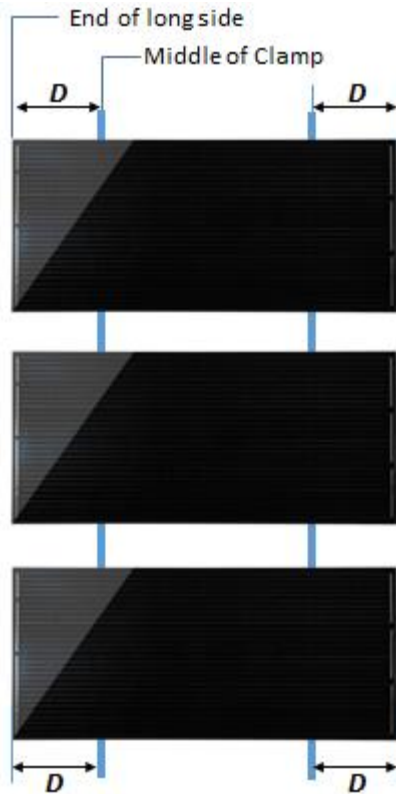

FIGURE 1: LANDSCAPE ORIENTATION  
SEE TABLE 5

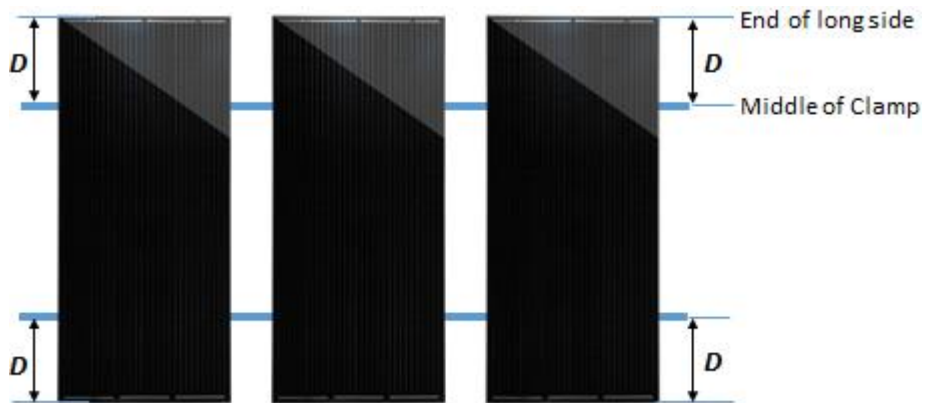
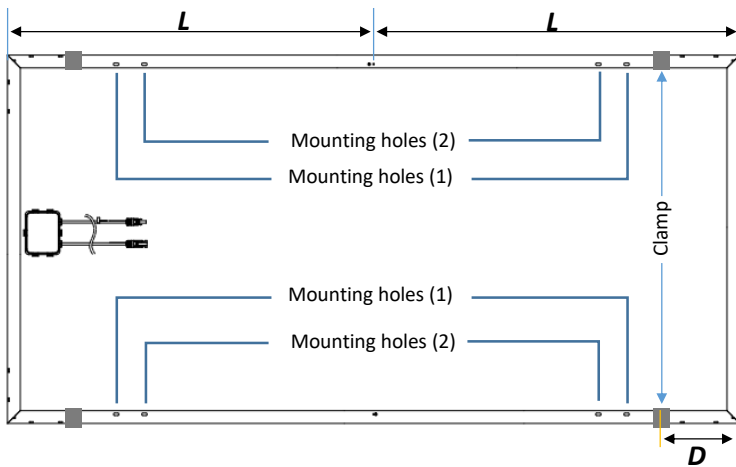

FIGURE 2: PORTRAIT ORIENTATION  
SEE TABLE 5

**\*Mounting Distance [D] – distance between edge of module and middle of clamp location. This is assuming that modules are mounted on a certified railing system.**

TABLE 5: SNOW & WIND LOAD AS SPECIFIED BY UL1703

INSTALLATION TYPE	MODULE	*MOUNTING DISTANCE [D]	DESIGN LOAD FOR FRONT	DESIGN LOAD FOR BACK
Mounting holes by bolt fitting	SQ8T/SQ8K	Mounting Holes (1) : 297mm Mounting Holes (2) : 374mm	3754 Pa	3754 Pa
	SR8T/SR8K	Mounting Holes (1) : 300mm Mounting Holes (2) : 377mm	3754 Pa	3754 Pa
	SQ9S/ SQ7S/ SO9J/ SO7J	Mounting Holes (1) : 370mm Mounting Holes (2) : 447mm	3754 Pa	3754 Pa
	SR9S/SR7S	Mounting Holes (1) : 373mm Mounting Holes (2) : 450mm	3754 Pa	3754 Pa
Clamps	All model	0.225L - Mounting hole(1)	2400 Pa	2400 Pa
		Mounting hole(2) - 0.45L	3754 Pa	3754 Pa
		0.45L - 0.625L	2400 Pa	2400 Pa



**L** – Distance between end of module long side and center of the long side

For Bolt fitting, Module shall be bolted to support structures through four mounting holes using M7\*16mm (or ¼”\*16mm) bolts together with flat washer, spring washer and nut. The applied torque should be 16±2 Nm. For Clamp fitting, once the module is aligned and centered, fully tighten the screws in the end-clamps in place to 16±2 Nm. All the end clamps should be torqued to this value.

**Note: Allowable clamp minimum dimensions are as follows:**

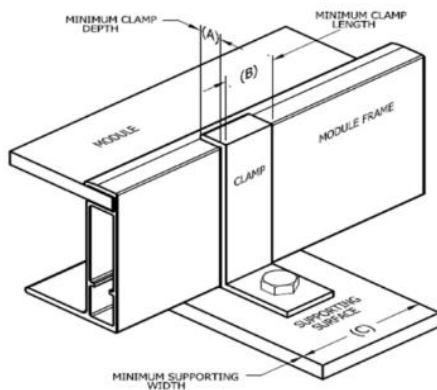

Diminsion	mm	inch
A	9.2	0.36
B	38	1.5

MISSION SOLAR ENERGY LLC

ELECTRONIC versions are uncontrolled except when accessed directly from document control directory. Printed copies are uncontrolled unless verified against online document.

COPYRIGHT 2019 MISSION SOLAR ENERGY LLC, ALL RIGHTS RESERVED

REVISION:[R13] 4/28/2020

RELEASE DATE: 11/16/2016

# MSE PERC 72 / MONO 72

## 1) SQ9S/SQ7S/SO9J/SO7J SERIES

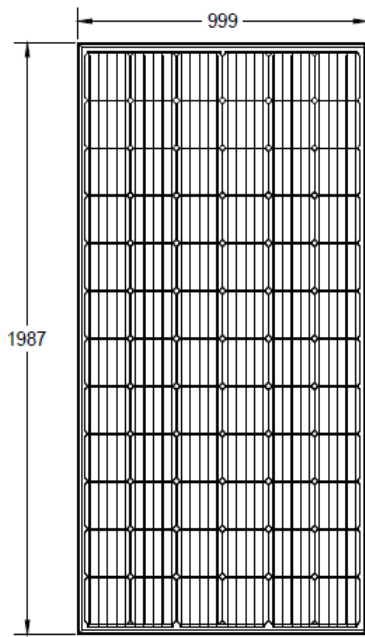

Front View



Side

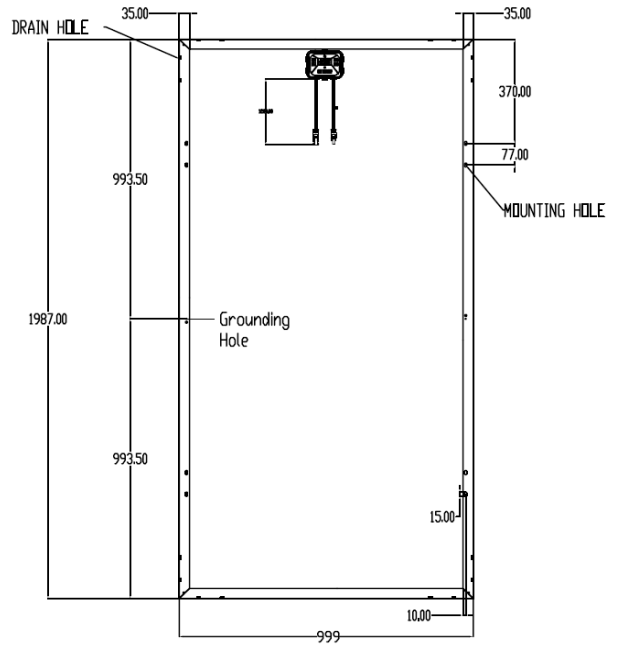

Back View

## 2) SR9S/SR7S SERIES

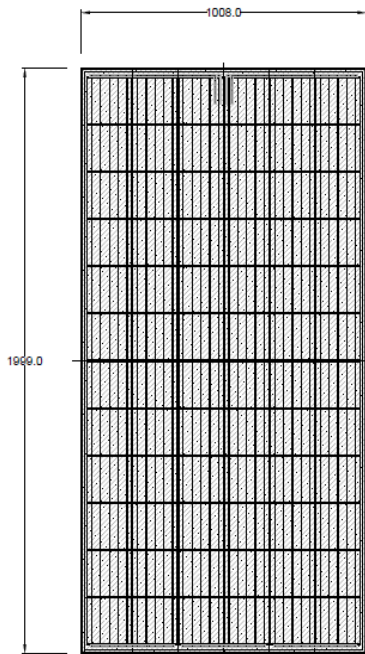

Front View

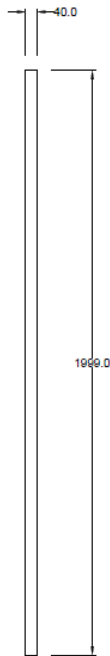

Side

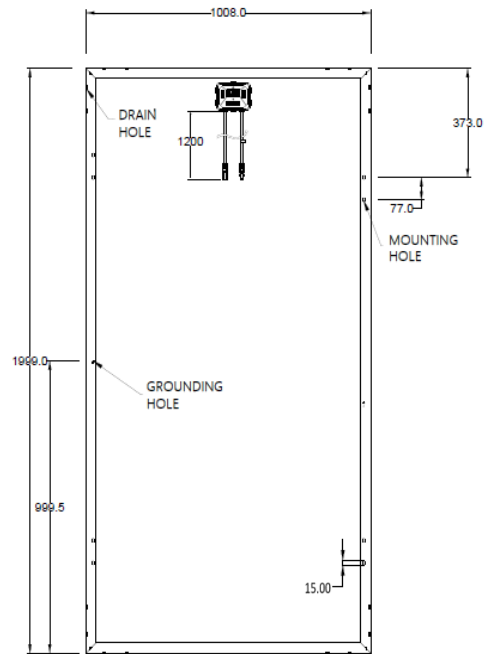

Back View

MISSION SOLAR ENERGY LLC

ELECTRONIC versions are uncontrolled except when accessed directly from document control directory. Printed copies are uncontrolled unless verified against online document.

COPYRIGHT 2019 MISSION SOLAR ENERGY LLC, ALL RIGHTS RESERVED

REVISION:[R13] 4/28/2020

RELEASE DATE: 11/16/2016

### MSE PERC 60

#### 3) SQ8T/SQ8K SERIES

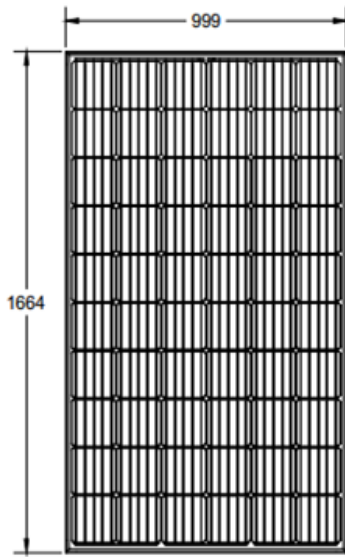

Front View

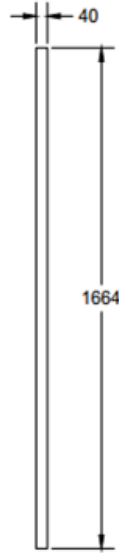

Side

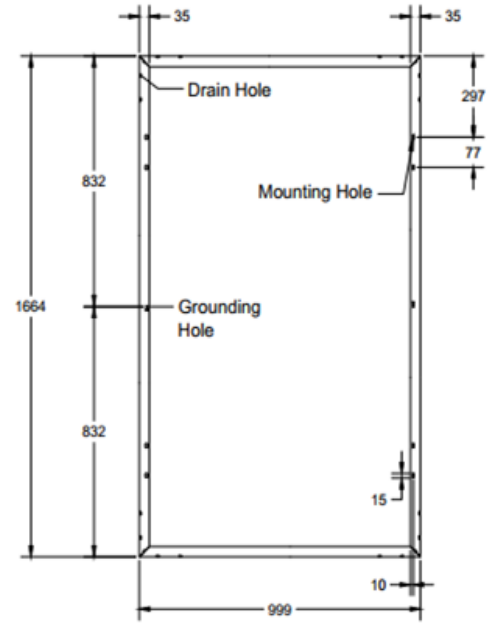

Back View

#### 4) SR8T/SR8K Series

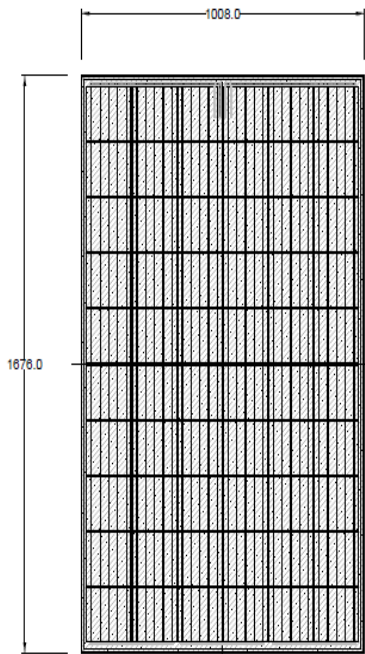

Front View

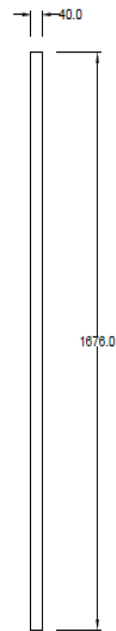

Side

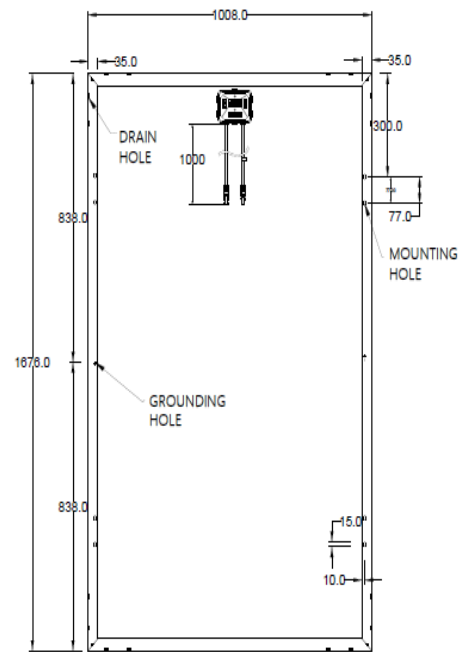

Back View

MISSION SOLAR ENERGY LLC

ELECTRONIC versions are uncontrolled except when accessed directly from document control directory. Printed copies are uncontrolled unless verified against online document.

COPYRIGHT 2019 MISSION SOLAR ENERGY LLC, ALL RIGHTS RESERVED

REVISION:[R13] 4/28/2020

RELEASE DATE: 11/16/2016

## 10.0 GROUNDING INSTRUCTIONS

A module with exposed conductive parts is considered to be in compliance with UL 1703 and IEC 61730 only when it is electrically grounded in accordance with the instructions presented below and the requirements of the National Electric Code. To reduce the possibility of electrical shock, ground the frame of the module or array before wiring the circuit using a grounding method that meets NEC requirements for grounding solar electrical systems. In order to install, Mission Solar Energy modules shall be grounded using grounding hardware that has been certified to meet requirements for grounding systems in UL467, UL1703 or UL1741 on anodized aluminum frames. Mission Solar Energy recommends one of the following methods of grounding the module frame. The attachment must be made in conformance with the grounding device manufacturer's instructions and be used with a racking system in compliance with UL Outline (Standard) 2703 where this module has been evaluated with that racking system.

### 10.1 WEEB-UIR

The WEEB washer family of products can be used to bond anodized aluminum, galvanized steel, steel and other electrically conductive metal structures. All installations shall be in accordance with NEC requirements in the USA and with CSA C22.1 in Canada. The WEEB washers are for use with modules that have a maximum fuse rating of less than 25A. Use WEEB-UIR to bond solar modules to module mounting purlin and torque fasteners to 7ft-lb / 9.5N-m use Penetrox-A on threads. The following UL Recognized component, Bonding Washer, manufactured by BURNDY LLC (E351343) in combination with the following model number PV module(s), used with a flat washer (optional), a M5 size nut and bolt (see Figure 3 for details).

FIGURE 3

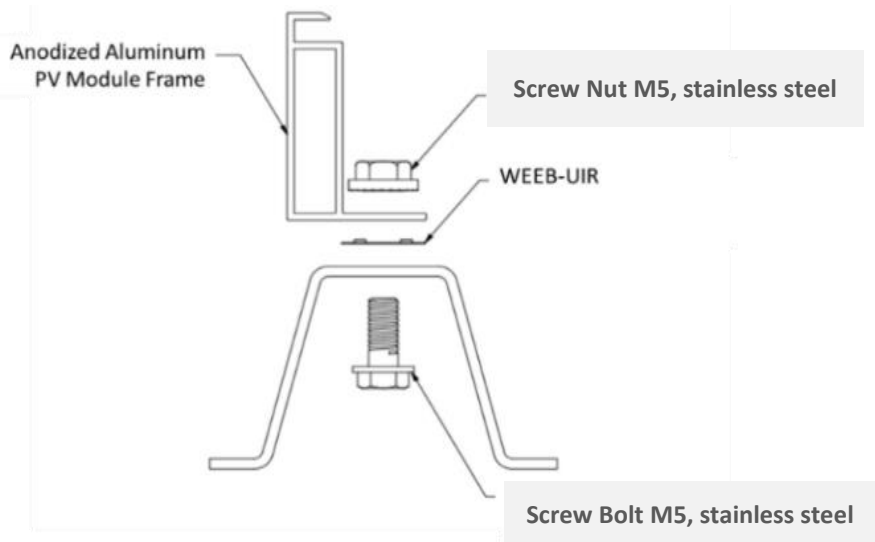

#### MISSION SOLAR ENERGY LLC

ELECTRONIC versions are uncontrolled except when accessed directly from document control directory. Printed copies are uncontrolled unless verified against online document.

**COPYRIGHT 2019 MISSION SOLAR ENERGY LLC, ALL RIGHTS RESERVED**

REVISION:[R13] 4/28/2020

RELEASE DATE: 11/16/2016



## 11.0 ELECTRICAL INSTALLATION

### 11.1 LOCAL / NATIONAL CODE AND LOCAL REGULATION

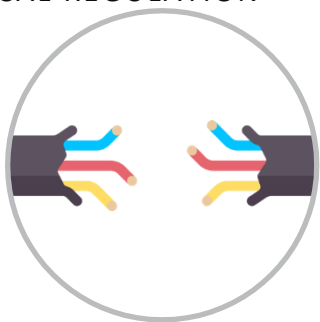

To carry out installation, local regulations that may apply should be taken into account such as NEC (USA) or Canadian Electrical Code (Canada). Wiring should be performed by a qualified and licensed professional. Wiring should be protected to help ensure personal safety and to prevent damage. All modules connected in series should be of same model number and/or same type. Do not connect modules in parallel without using a combiner box or equivalent.

Under normal conditions, a photovoltaic module is likely to experience conditions that produce current and/or voltage other than reported at standard test conditions. The requirements of the National Electric Code (NEC) in Article 690 shall be followed to address these increased outputs. In installations not under the requirements of the NEC, the values of ISC and VOC marked on this module should be multiplied by a factor of 1.25 when determining component voltage ratings, conductor capacities, over current device ratings and the size of controls connected to the PV output.

### 11.2 WIRING

Mission Solar PV modules come with a factory assembled Junction Box. Do not open the junction box in any case. Wiring must be done in accordance with local/national code and regulations; wear protective gloves and shoes to avoid electric shock. Address the following recommendations:

- The modules combined in parallel will produce a specific current output. Each series string or module is required to be fused. Table 1 describes the maximum fuse size allowed.
- Do not connect the modules if the connectors are wet.
- Be sure to put the cables away from sharp edges.

- If you need additional cables you must use exclusively solar cable of 12AWG/4mm<sup>2</sup> minimum cross-sections, with ability to work in a temperature range of at least -40°C and 90°C.
- Install the modules so that water from rain or condensation cannot penetrate inside the cable conduits.
- Fix cables to the structure so that the connectors are protected from water ingress. Cables should be held by UV resistant clamps or ties.
- To minimize possible effects of lightning induced voltages, the surface of all conductive loops must be as small as possible.
- Check that the wiring is correct before starting the installation by verifying that the open voltage is within expected values.
- Protect cables that could suffer mechanical damage.
- Avoid direct sunlight on cables.
- Maximum series fuse rating 20A.
- Details for wiring in accordance with the NEC, and that the grounding method of the frame of arrays shall comply with the NEC, article 250.
- Installation shall be in accordance with CSA C22.1, Safety Standard for Electrical Installations, Canadian Electrical Code and Part 1.
- Modules may be connected in series (voltage additive) and/or in parallel (current additive) to produce the appropriate electrical output. When connecting modules in parallel, each module (or series string of modules so connected) shall be connected according to the maximum series fuse as specified.
- Recommended series connection of module open circuit voltage should not exceed 80% limits range of the system voltage and the fuse should be connected at the end of each array.
- The installation instructions specify that grounding is achieved through securement to the array frame. The array frame must be grounded in accordance with NEC Article 250.

### 11.3 CONNECTORS

- Keep connectors dry and clean. Ensure that connector caps are hand-tight before connecting the modules.
- Do not attempt to make an electrical connection with wet, soiled, or otherwise faulty connectors.
- Avoid sunlight exposure and water immersion of the connectors. Avoid allowing connectors to rest on the ground.
- Ensure cable connectors are UL and Canadian code complaint.
- Faulty connections can result in arcs and electrical shock.
- Check that all electrical connections are securely fastened.
- Make sure that all locking connectors are fully engaged and locked.

CONNECTOR MODEL NAME	ALLOWABLE MATING CONNECTOR MODEL NAME	MANUFACTURER
PV-KBT4-EVO 2/6II-UR	PV-KST4-EVO 2/6II-UR	Staubli Electrical Connectors AG <a href="http://www.staubli.com">www.staubli.com</a>
PV-KBT4/6II-UR	PV-KST4/6II-UR	Staubli Electrical Connectors AG <a href="http://www.staubli.com">www.staubli.com</a>
05-8	05-8	RENHE SOLAR <a href="http://www.renhesolar.com">www.renhesolar.com</a>
PV-JM608	PV-JM608	Zhejiang Jiaming Tianheyuan PV Technology Co., Ltd <a href="http://en.jmthy.com">en.jmthy.com</a>

PV-KBT4-EVO 2/...-UR



PV-KBT4...



05-8



PV-KST4-EVO 2/...-UR



PV-KST4...



JM608



### 11.4 DIODES

- The junction boxes used with Mission Solar Energy modules contain bypass diodes wired in parallel with the PV cell strings.
- In the case of partial shading, the diodes bypass the current generated by the non-shaded cells, thereby limiting modules heating and performance losses. Bypass diodes are not over-current protection devices.
- Bypass diodes divert current from the cell strings in the event of partial shading. In the event of a known or suspected diode failure, installers or maintenance providers should contact Mission Solar Energy.
- Never attempt to open the junction box.

## 12.0 MAINTENANCE

### 12.1 VISUAL INSPECTION

Mission Solar Energy recommends that PV systems be periodically inspected by the installer or other qualified personnel. The purpose of the PV system inspection is to ensure that all system components are functioning properly. At a minimum, this inspection should confirm the following:

- All cables and connector attachments are undamaged and properly secured.
- No sharp objects are in contact with the PV module surfaces.
- PV modules are not shaded by unwanted obstacles and/or foreign material.
- Mounting and grounding components are tightly secured with no corrosion.
- Defects should be addressed immediately.

### 12.2 CLEANING

- The dust accumulated on the front transparent substrate may reduce the power output, and may even cause regional hot-spot effect.
- It's usually not dangerous for the accumulated dust to reduce the sunshine because the light intensity is still homogeneous and power reduction is not usually obvious.
- When modules are installed, avoid environmental influence factors that cast shadows and cover part or all of the modules. This includes other modules, system support, bird drops, dust and so on. This debris may distinctly reduce the power output.
- The cleaning frequency depends on the accumulation frequency and can vary from 6 months to 2 years. Do not use alkaline, abrasive, alkali or acid materials, detergents, or cleaning solutions to clean the module.
- It is recommended to wipe the glass surface with a wet sponge or soft cloth. Please do not clean the glass with a cleaning agent which contains acid or alkali.

**[www.missionsolar.com](http://www.missionsolar.com)**

**Mission Solar Energy**

8303 S. New Braunfels Ave.  
San Antonio, Texas 78235  
info@missionsolar.com  
210-531-8600

MISSION SOLAR ENERGY LLC

ELECTRONIC versions are uncontrolled except when accessed directly from document control directory. Printed copies are uncontrolled unless verified against online document.

COPYRIGHT 2019 MISSION SOLAR ENERGY LLC, ALL RIGHTS RESERVED

REVISION:[R13] 4/28/2020

RELEASE DATE: 11/16/2016